

Indoor Recessed Mount PIR Detector

# AP-20NBR(C)

Curtain area/Battery operated model

6.0 m (20' ) curtain detection area at 4.5 m (14' 9" ) mounting height

<< Contents >>

<b>Before installation</b>	
- Manufacturer' s statement	Page <b>2</b>
- Parts identification	<b>3</b>
<b>1 Settings</b> <b>4</b>	
<b>2 Installation</b>	
<b>3 Checking</b> <b>8</b>	
<b>Others</b>	
- Specifications	<b>9</b>
- Dimensions	<b>10</b>
- Detection area	<b>10</b>
- Troubleshooting	<b>11</b>
- Timing chart	<b>11</b>
- Compliance	<b>12</b>

Before installation

- Manufacturer's statement

Symbol	Meaning	Symbol	Meaning
	Failure to follow the instructions provided with this indication and improper handling may cause death or serious injury.		Check mark indicates recommendation.
	Failure to follow the instructions provided with this indication and improper handling may cause injury and/or property damage.		Nix sign indicates prohibition.
		<b>NOTE</b>	Special attention is required to the section of this symbol.

Warning

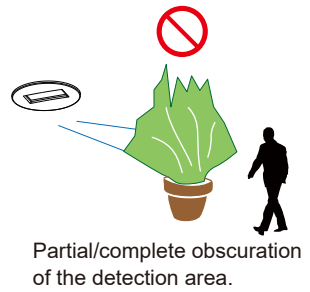
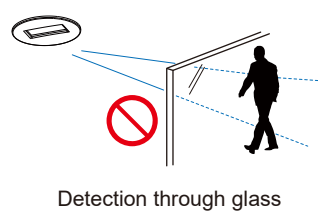
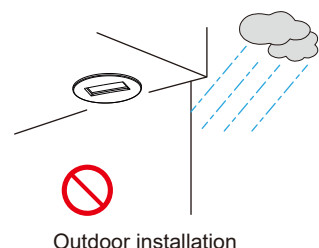

Caution

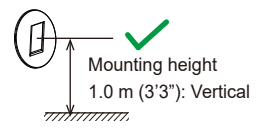
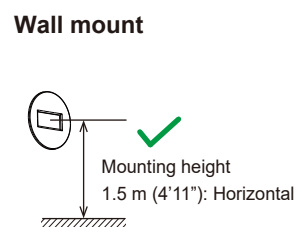
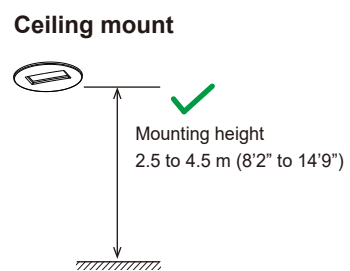
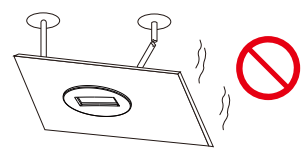
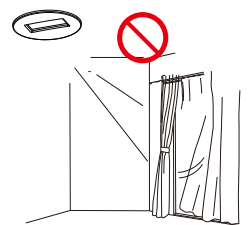
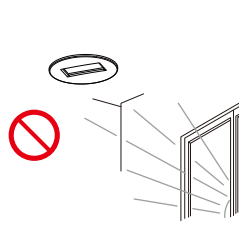

## - Parts identifications

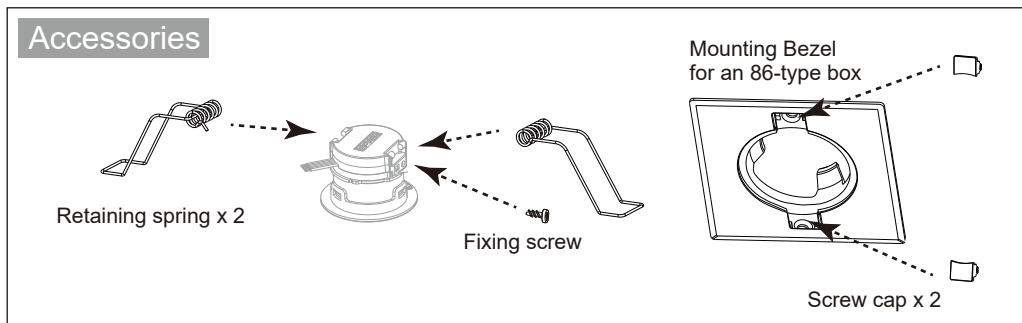
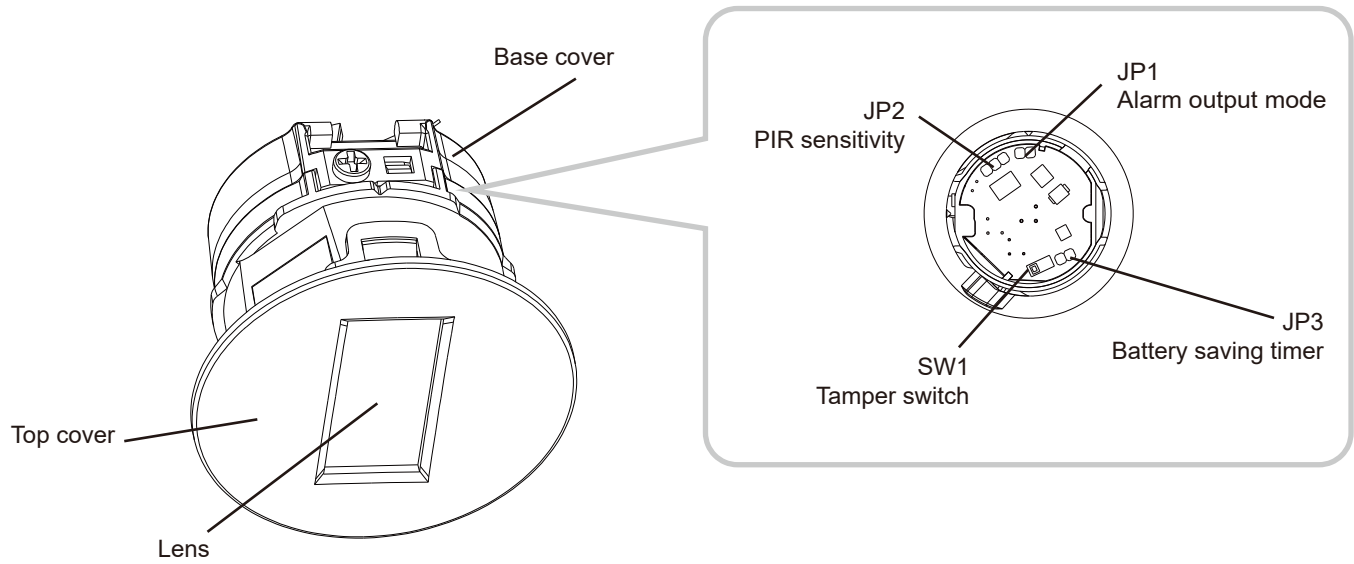

# 1 Settings

## 1 Disassemble

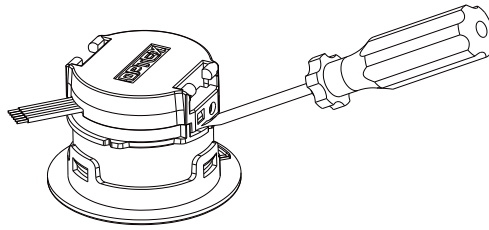

Open the base cover, and to set the detector.

## 2 Jumper pin settings

### JP1

Alarm output mode

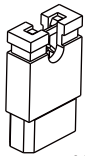

N.C. (default)

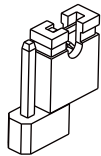

N.O.

### JP2

PIR sensitivity

Turn the jumper PIN by 90 degrees to prevent interference with the casing.

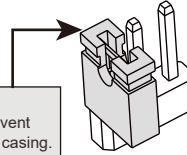

H (recommended)

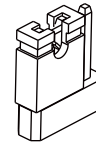

M (default)

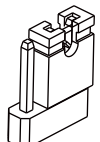

L

Mounting height: > 3.5 m (11'6")  
3.0 to 3.5 m (9'10" to 11'6")  
< 3.0 m (9'10")

### JP3

Battery saving timer

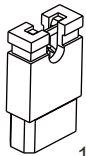

120 s (default)

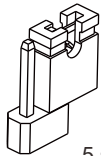

5 s

## 3 Assemble

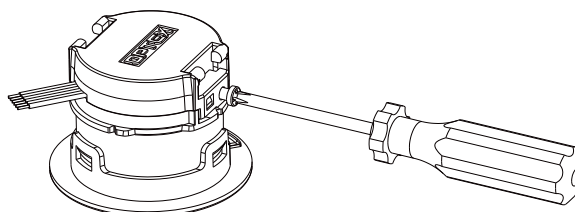

Close the base cover, and fasten the screw to fix the cover.

## 2 Installation

### 2-1. Ceiling mount *without switch box*

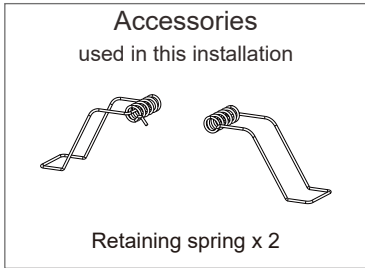

- 1 Install a retaining spring on both sides.  
(follow the illustrated arrow steps to complete the assembly of  
the retaining spring.)

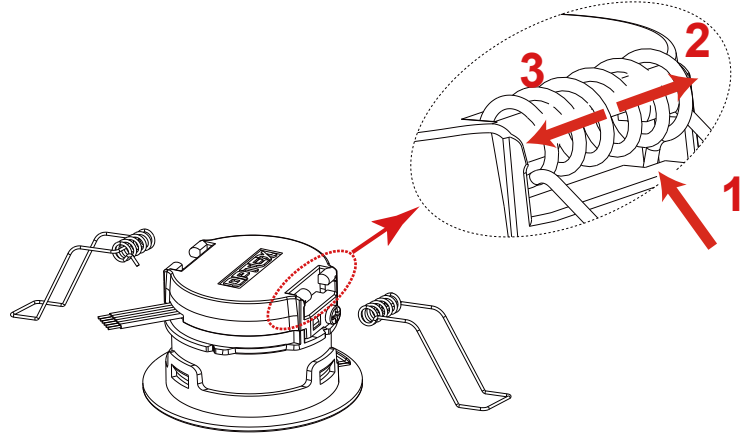

- 2 Make a  $\varnothing 45$  mm (1.77") hole in the ceiling for mounting.

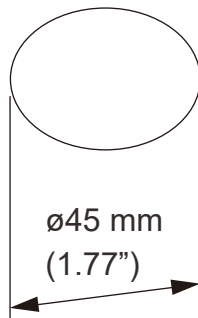

- 3 Insert the detector into the hole so that the retaining springs come first.

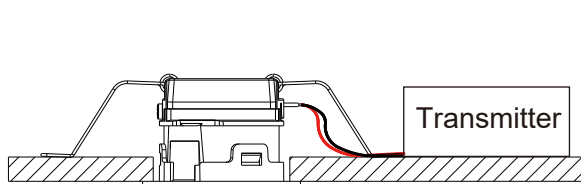
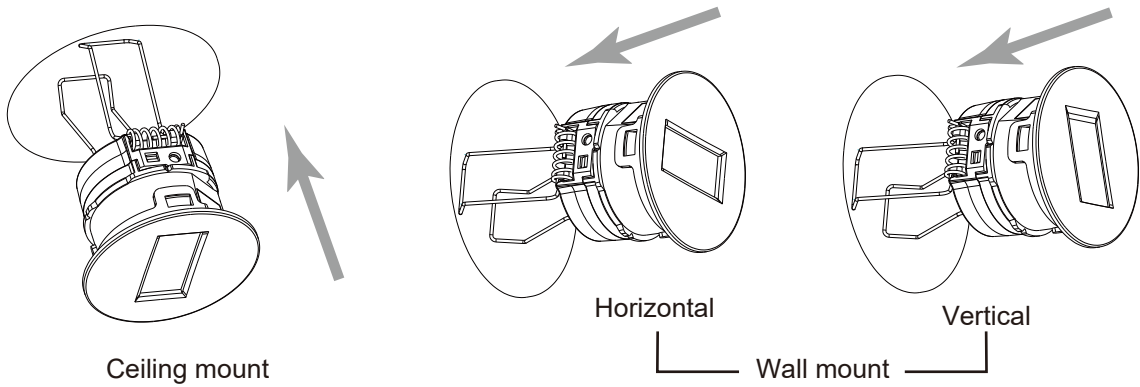

#### NOTE

Be sure to arrange the wires with a downward slope to prevent water ingress into the detector.

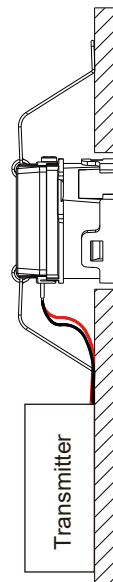

## 2-2. Ceiling mount *with 86-type box*

**NOTE**

For the 86-type box mount, dual 86-type boxes are recommended with the additional one used to accommodate the transmitter.

**Accessories**  
used in this installation

Mounting Bezel  
for an 86-type box

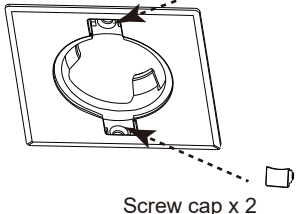

Screw cap x 2

**Options**  
to procure in the market

86-type box x 1 or 2  
Screw x 2

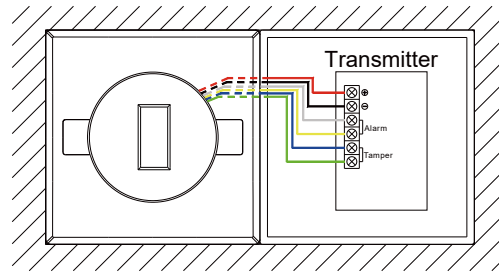

**1** Prepare an 86-type box on the ceiling.

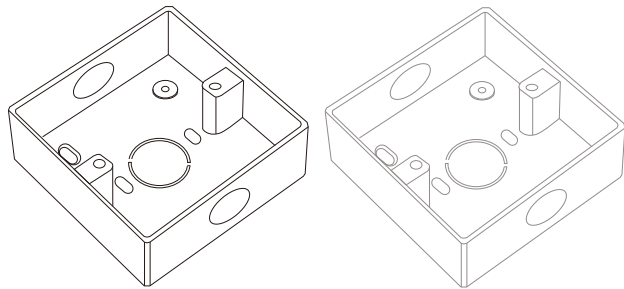

**2** Install the detector into the 86-type box.

**Ceiling mount**

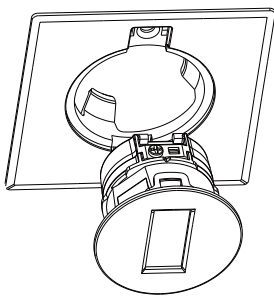

**Wall mount**

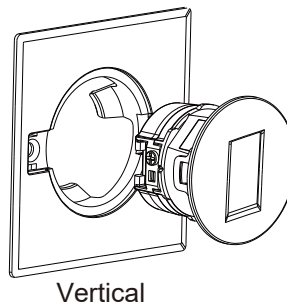
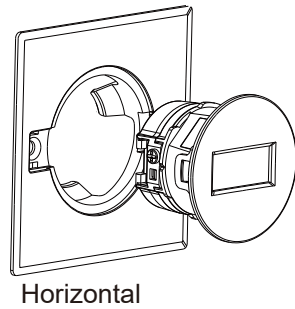

**NOTE**



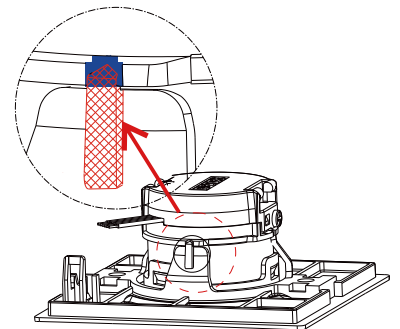

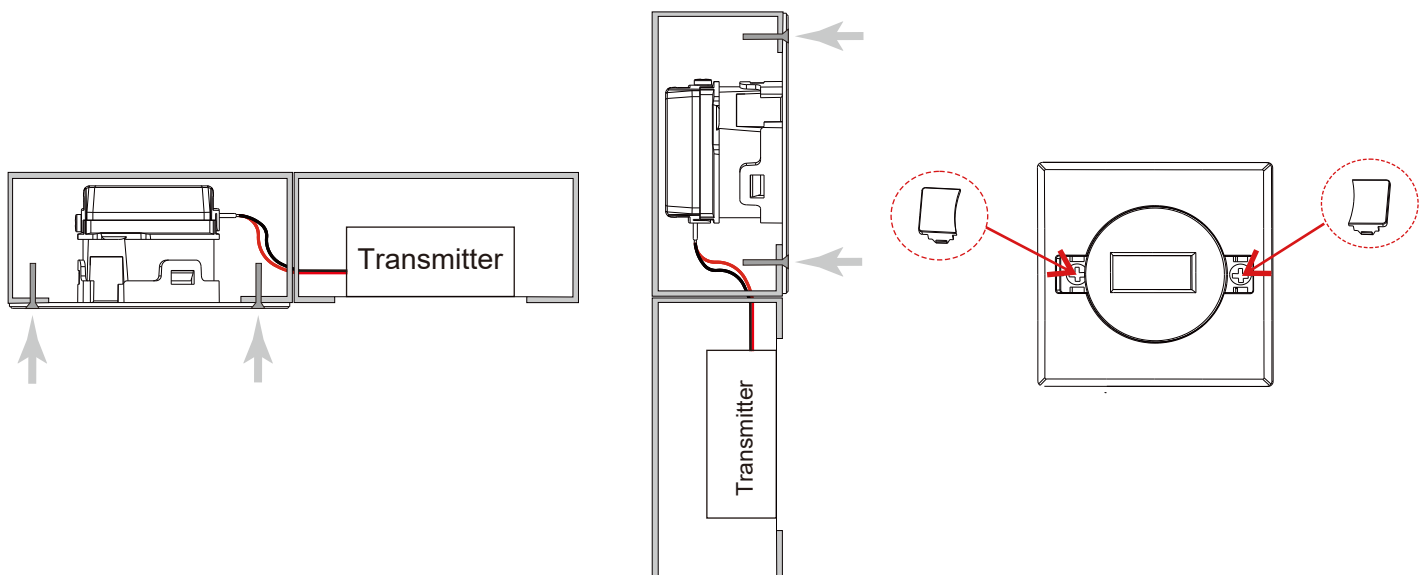

Align the bump with the triangle recess as illustrated in the figure.



**3** Fix the detector with two screws and cover their heads with two caps.



## 2-3. Wiring

	[1] Red	Power supply: Positive
	[2] Black	Power supply: Negative
	[3] White	Alarm output
	[4] Yellow	Alarm output
	[5] Green	Tamper output
	[6] Blue	Tamper output

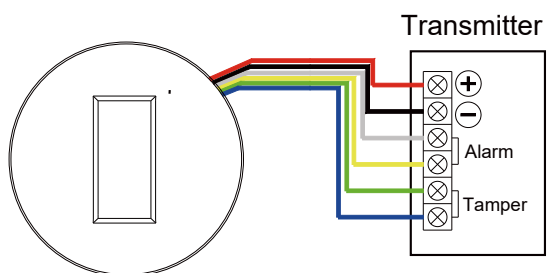

# 3 Checking

## 3-1. Walk test

1 Power on.

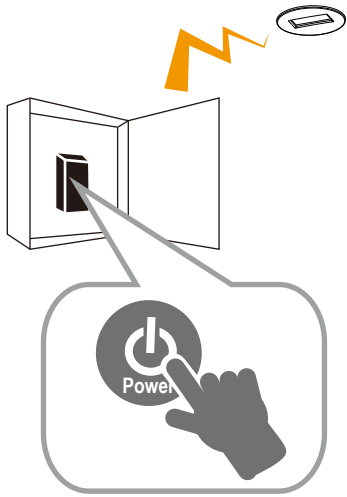

2 Wait for 60 seconds to complete the warm-up time.

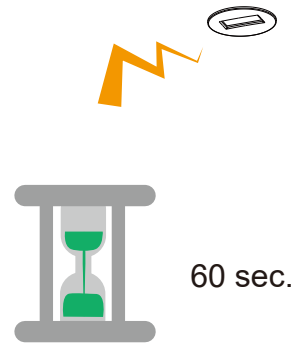

3 Walk in the detection area to check the detecting performance.

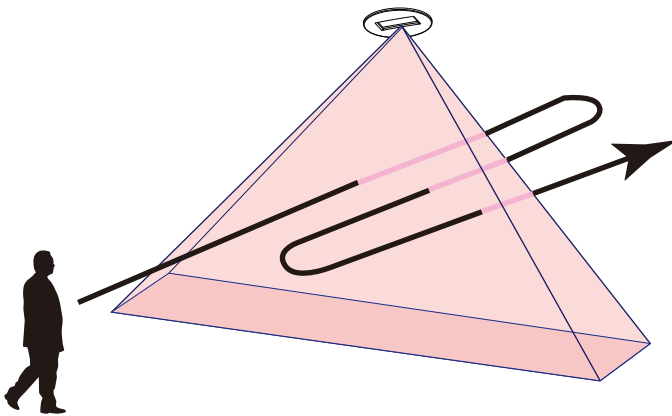

4 Start operation.

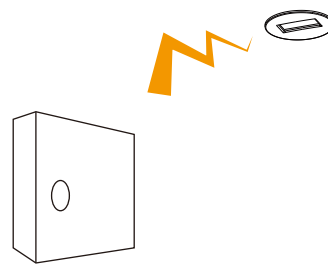



## - Specifications

Model	AP-20NBR(C)	
Detection method	Passive infrared	
Detection area	< Ceiling mount > 6.0 m x 1.0 m (20' x 3'3") at 4.5 m (14'9") height	< Wall mount > 6.0 m x 4.5 m (20' x 14'9") at 1.5 m (4'11") height
Mounting height	2.5 m to 4.5 m (8'2" to 14'9")	1.5 m (4'11"): Horizontal 1.0 m (3'3"): Vertical
Mounting type	Recessed ceiling mount/ Wall mount/ 86-type box mount	
Sensitivity	2.0°C at 0.6 m/s (3.6°F at 2'/s)	
Detection speed	0.3 to 3.0 m/s (1'/s to 9'10"/s)	
LED indicator	Warm-up upon power on: blinking Stand-by: off Walk test: solid on Alarm: off	
Alarm cycle	Approx. 2 s	
Battery saving timer	120 s/ 5 s selectable	
Alarm output	N.O./N.C., 3.6 V DC 10 mA max.	
Tamper switch	N.C. 28 V DC 100 mA max. The contact opens once the casing is detached.	
Warm-up time	Approx. 60 s	
Power supply	2.7 to 3.6 V DC (CR123A battery)	
Current	3 V DC Stand-by: 10µA, Max.: 4 mA	
PIR sensitivity	H/ M/ L	
Weight	50 g (1.76 oz)	
Operation temperature	-20 to +50°C (-4°F to +122°F)	
Operation humidity	< 95%	
Location	Indoors	
Dimensions	ø52 x 35.5 mm (ø2.05 x 1.40 in.): without switch box mount	
	86 x 86 x 36.5 mm (3.39 x 3.39 x 1.44 in.): with 86-type box mount	

- Specifications and designs are subject to change without prior notice.
- These units are designed to detect an intruder and activate an alarm control panel. Being only a part of a complete system, we cannot accept responsibility for any damages or other consequences resulting from an intrusion.

## - Dimensions

Without switch box mount

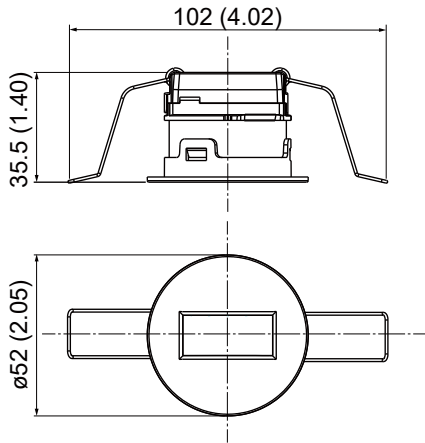

With 86-type box mount

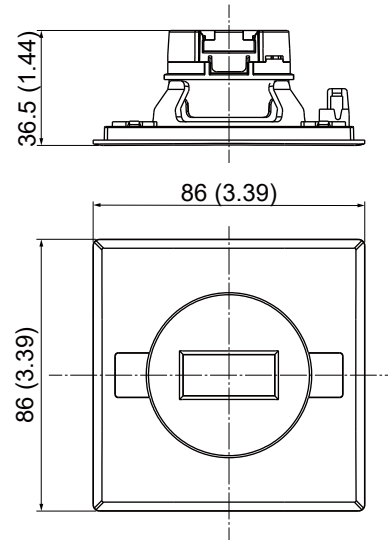

Unit: mm (inch)

## - Detection area

Ceiling mount

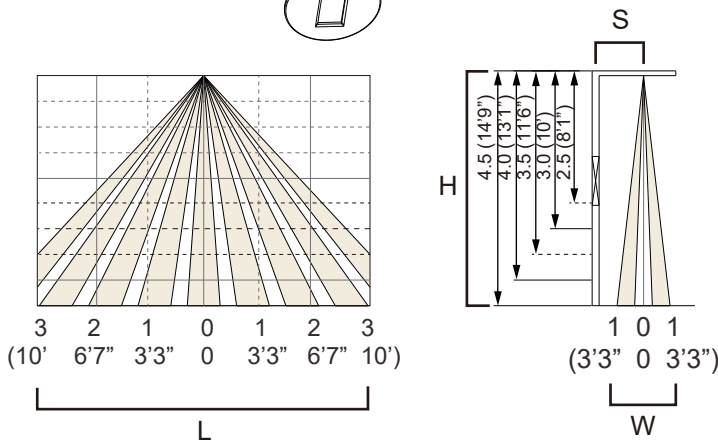

Maximum detection area

Mounting height (H)	2.5 (8' 2")	3.0 (9' 11")	3.5 (11' 6")	4.0 (13' 1")	4.5 (14' 9")
Area depth (W)	0.6 (2')	0.7 (2' 4")	0.8 (2' 7")	0.9 (2' 11")	1.0 (3' 3")
Area width (L)	3.3 (10' 10")	4.0 (13' 1")	4.6 (15' 1")	5.4 (17' 7")	6.0 (20')
Recommended distance to the wall (S)	0.7 (2' 4")	0.8 (2' 7")	0.9 (2' 11")	1.0 (3' 3")	1.2 (3' 9")

Unit: m (ft., in.)

Wall mount

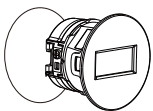

Horizontal

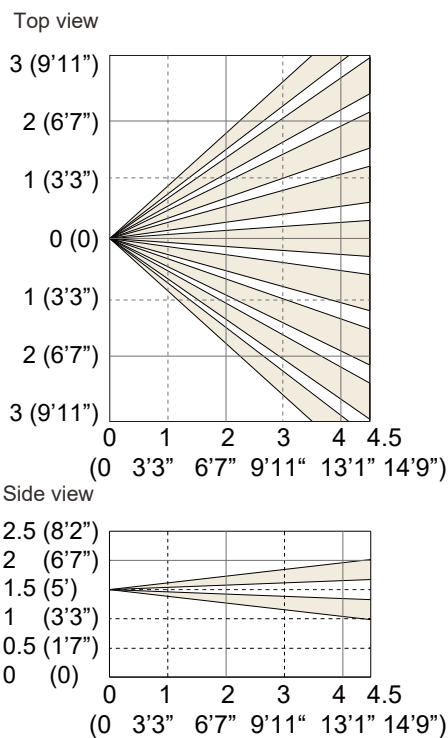

Top view

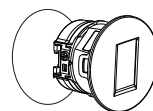

Vertical

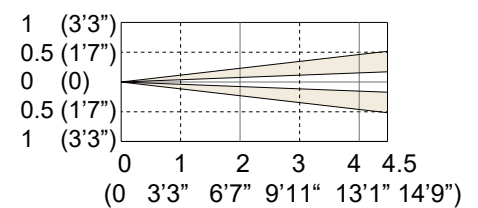

Side view

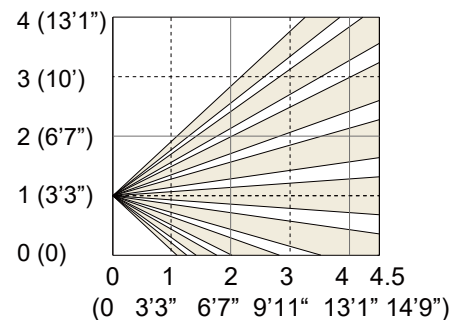

Unit: m (ft.)

## - Timing chart

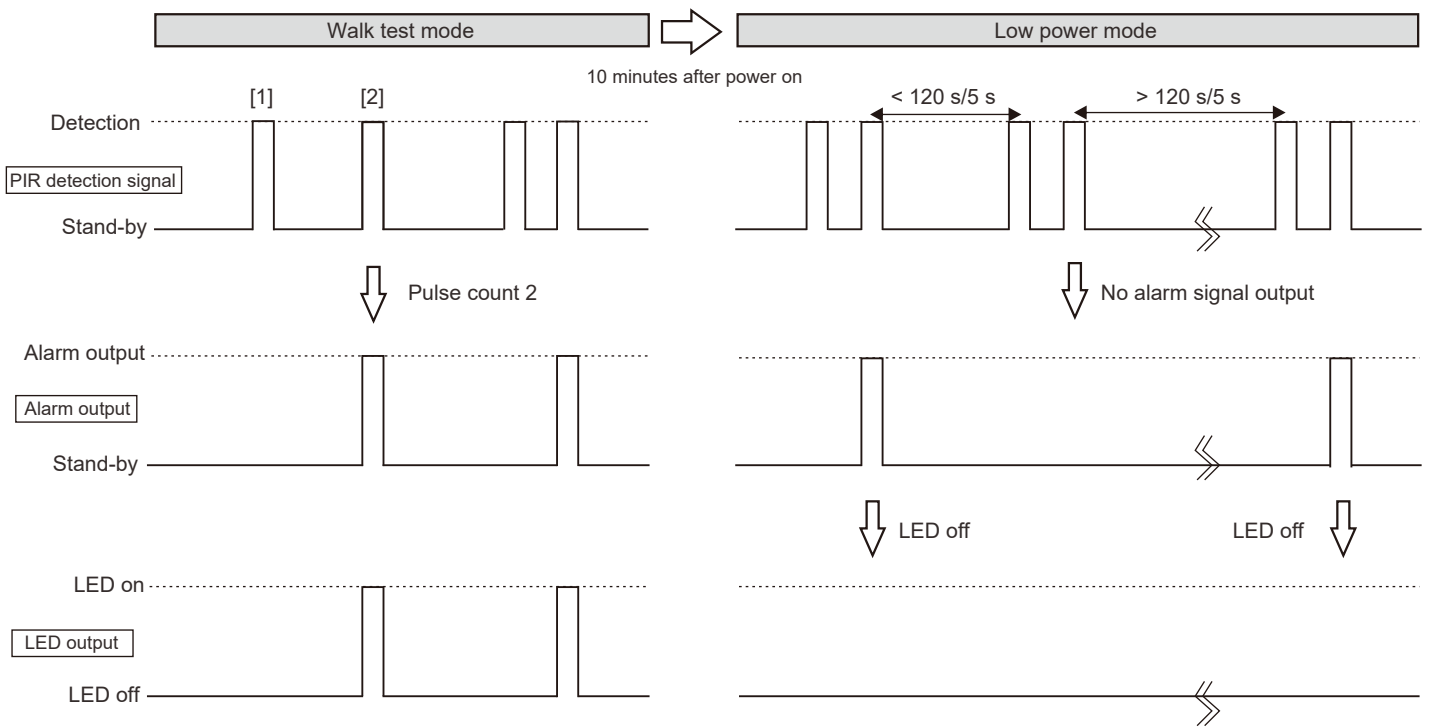

## - Troubleshooting

Problem	Cause	Solution
The LED is off.	The power supply voltage does not meet the requirement due to disconnection from the power supply or low voltage.	Check the power supply of the detector. Refer to "Specifications" on the page 9 for the power supply voltage.
	Incorrect detection area.	Adjust the detection area. Refer to "Detection area" on the page 10.
	The detector is in low power mode.	Power on the detector again if an additional walk test is needed.
The LED is on even there is no person in the detection area.	A moving object exists in the detection area, such as a fluttering curtain or a swinging wall-mounted pendant.	Remove the moving object from the detection area or change the detector location.
	The temperature changes rapidly in the detection area due to a heat source, such as a radiator or air conditioner.	Remove the heat source from the detection area or change the detector location.
The LED is on but the detector does not transmit signals.	Relay contact adhesion or damage occurs due to overload.	Check the output load. Repair or replace the damaged part.
	Improper wiring.	Connect the wires for the detector correctly.
The detector fails to warm up in 60 seconds after power on and the LED blinks continuously.	A moving object exists in the detection area during the warm-up period of the detector.	Be sure that there is no moving object in the detection area during the warm-up period of the detector.
	The detector fails to work properly.	Repair or replace the detector.

## - Compliance

### ■ EU & UK contact information



<https://navi.optex.net/cert/contact/>



**OPTEX INC./AMERICAS HQ (U.S.)**  
[www.optexamerica.com](http://www.optexamerica.com)

**OPTEX (EUROPE) LTD./EMEA HQ (U.K.)**  
[www.optex-europe.com](http://www.optex-europe.com)

**OPTEX SECURITY B.V.**  
**(The Netherlands)**  
[www.optex-europe.com/nl](http://www.optex-europe.com/nl)

**OPTEX CO., LTD. (JAPAN)**  
[www.optex.net](http://www.optex.net)

**OPTEX SECURITY SAS (France)**  
[www.optex-europe.com/fr](http://www.optex-europe.com/fr)

**OPTEX SECURITY Sp.z o.o. (Poland)**  
[www.optex-europe.com/pl](http://www.optex-europe.com/pl)

**OPTEX PINNACLE INDIA,**  
**PVT., LTD. (India)**  
[www.optexpinnacle.com](http://www.optexpinnacle.com)

**OPTEX KOREA CO.,LTD. (Korea)**  
[www.optexkorea.com](http://www.optexkorea.com)

**OPTEX (DONGGUAN) CO.,LTD.**  
**SHANGHAI OFFICE (China)**  
[www.optexchina.com](http://www.optexchina.com)

**OPTEX (Thailand) CO., LTD. (Thailand)**  
[www.optex.co.th](http://www.optex.co.th)

Copyright (C) 2022 OPTEX CO.,LTD.