

Detection Area

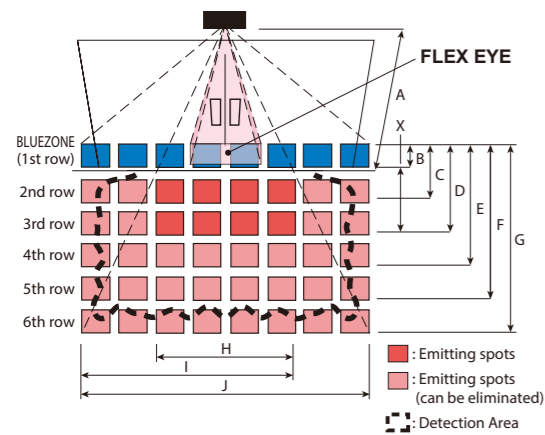

unit : m

	2.00	2.30	2.50	3.00
A	2.00	2.30	2.50	3.00
B	0.13	0.16	0.17	0.21
C	0.38	0.46	0.50	0.60
D	0.71	0.86	0.94	1.13
E	0.84	1.01	1.09	1.31
F	1.34	1.62	1.76	2.11
G	1.75	2.11	2.29	2.75
H	0.92	1.11	1.20	1.45
I	1.49	1.80	1.95	2.34
J	2.06	2.48	2.69	3.23

Charts show the values in the following area angle adjustment settings ; Depth :0° Width :0°

Specifications

Model	AIR-SLIDE 2
Cover color	Black
Mounting height	2.0 m to 3.0 m
Detection area	See DETECTION AREA
Detection method	Active infrared reflection(*1)
Area angle adjustment	Depth : -8° to +8° Width : ±7° (2 clicks with 3.5° every click-Left/Right)
FLEX EYE angle adjustment	Depth : -14° to +2° Width : ±42° (7 clicks with 6° every click-Left/Right)
Power supply (*2)	12 to 24 V AC ±10% (50 / 60 Hz) 12 to 30 V DC ±10%
Power consumption	< 2.5 W (< 6 VA at AC)
Operation indicator	See Operation indicator table
Activation output	Form A relay 50 V 0.3 A Max. (Resistance load)
Safety output	Form A relay 50 V 0.3 A Max. (Resistance load)
Operating temperature	-35 to +55°C
Operating humidity	< 80%
Noise level	< 70 dBA
Output hold time	Approx. 0.5 sec.
Response time	< 0.3 sec.
IP rate	IP54
Weight	230 g
Accessories	1 Operation manual 2 Mounting screws 1 Mounting template 1 Area adjustment tool 1 Cable 3 m (8 × 0.22 mm ² AWG24) (*3)

*1 : BLUEZONE (1st row), 2nd and 3rd rows have a presence detection function.

*2 : When using this sensor, the sensor has to be connected to a door system which has the SELV circuit.

*3 : Overcurrent protection with less than 2A.

Dimensions

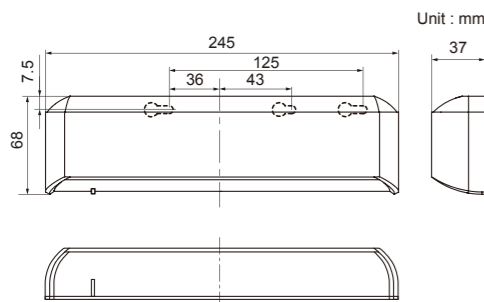

Option

Touchless plate



Unit : mm

Active Infrared Door Sensor with Built-in Touchless Switch AIR-SLIDE 2

Wave your hand Here to open door.



Manufacturer / Asia sales Div.

OPTEX CO.,LTD.

5-8-12 Ogoto Otsu Shiga 520-0101 Japan
TEL.: +81- (0) 77-579-8700 FAX.: +81- (0) 77-579-7030
WEBSITE: www.optex.co.jp/as/eng/index.html

North and South American Subsidiary

OPTEX Technologies Inc.

Corporate Headquarters
18730 S. Wilmington Ave. Suite 100 Rancho Dominguez, CA 90220 U.S.A.
TOLL-FREE: 800 877 6656 FAX.: +1 310 214 8655
WEBSITE: www.ot-inc.com

East Coast Office

8510 McAlpines Park Drive, Suite 108 Charlotte, NC 28211 U.S.A.
TOLL-FREE: 800 877 6656 FAX.: +1 704 365 0818
WEBSITE: www.ot-inc.com

European Subsidiary

OPTEX Technologies B.V.

Henricuskade 17, 2497 NB The Hague, The Netherlands
TEL.: +31(0)70 419 41 00 FAX.: +31(0)70 317 73 21 E-MAIL: info@optex.eu
WEBSITE: www.optex.eu

Thailand Subsidiary

OPTEX(THAILAND) CO., LTD.

90 Cyberworld Tower (Tower B) Unit B 1702 17th Flr., Ratchadaphisek Rd., Huai Khwang, Bangkok10310 Thailand
TEL.: +66-2-168-3162 FAX.: +66-2-168-3163

Step 1

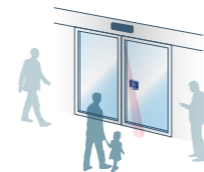

AIR SLIDE 2 does not detect pedestrians walking across.

Step 2



When a pedestrian approach his/her hand, the door opens.

Step 3

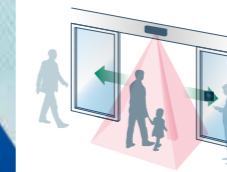

The door opens and the presence detection area keeps the door opened.

Step 4

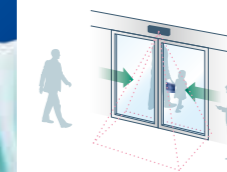

After the pedestrian walked through the door, the door is closed and then the presence detection area disappears.

Energy Saving

Eliminates unwanted activations due to cross traffic to improve air conditioning efficiency.

Shop owner

I would like to avoid unnecessary door openings due to cross traffic to improve air conditioning efficiency. My shop is facing with a busy street.



No wiring,
No contamination,
No wasting energy.



Germ Free

Eliminates one of the only cross contamination points on a low energy or knowing act door.

Nurse

Touch switch is contamination points for a knowing act or low energy door. I want to open a door without touching anything.



Safety

Provides safety throughout the threshold area keeping the door open until all people have moved away.

Chef

I want an automatic door for my kitchen but what I need is a limited detection area because my staff is walking around in front of a door.

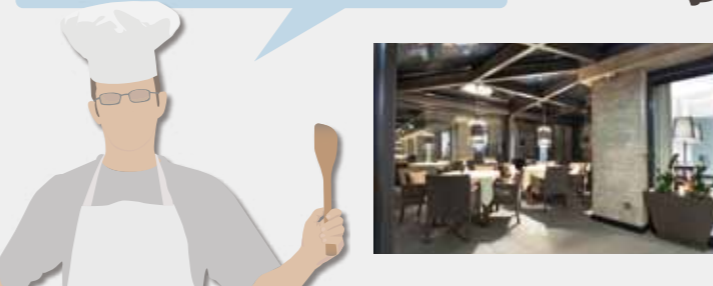

FLEX EYE (knowing act detection area)

Blue zone Active infrared

This sensor is designed to detect a hand approaching to a touchless plate as a knowing activation device. FLEX EYE means a detection area for the hand detection. When FLEXEYE mode is enabled, both FLEXEYE and 2nd to 4th row of detection area will detect passers.

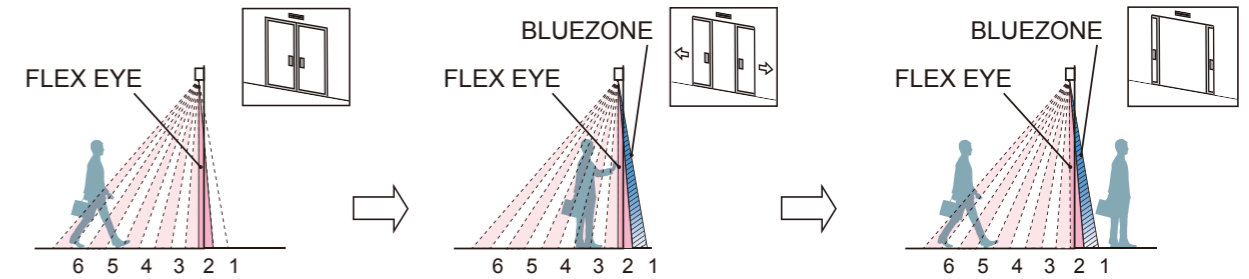

Width angle adjustment

Depth angle adjustment

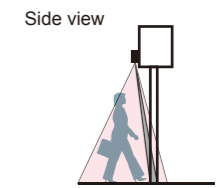
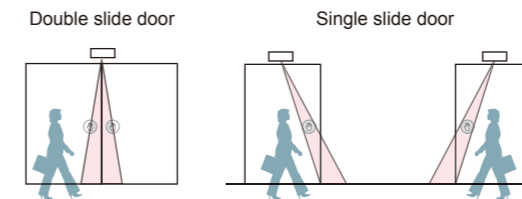
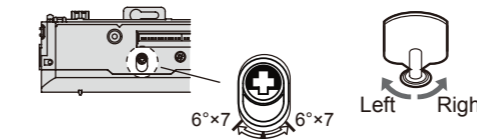

BLUEZONE technology



NO WIRING from the sensor to the touchless plate

How it Works: When the approach area detects a person or object, the sensor will activate the door and turn on the "BLUEZONE" which detects through the threshold. As long as someone is in the detection area, the sensor will keep the door in the open position. Once the area is cleared, the "BLUEZONE" will ignore the door panels and allow the door to safely close.



NO WIRING

Touchless plate

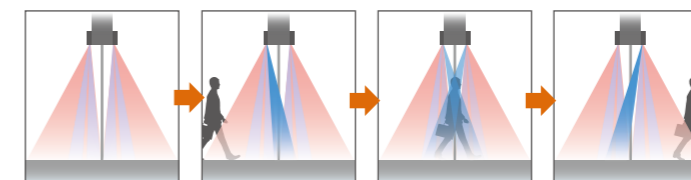

Detection Area

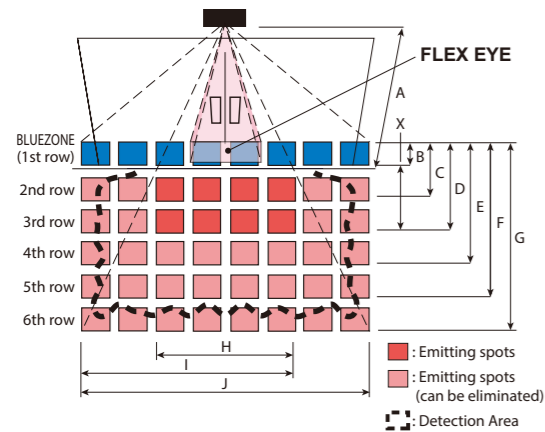

	feet, inch (m)			
A	6'7" (2.00)	7'7" (2.30)	8'2" (2.50)	9'10" (3.00)
B	5" (0.13)	6" (0.16)	7" (0.17)	8" (0.21)
C	1'3" (0.38)	1'6" (0.46)	1'8" (0.50)	1'12" (0.60)
D	2'4" (0.71)	2'10" (0.86)	3'1" (0.94)	3'8" (1.13)
E	2'9" (0.84)	3'4" (1.01)	3'7" (1.09)	4'4" (1.31)
F	4'5" (1.34)	5'4" (1.62)	5'9" (1.76)	6'11" (2.11)
G	5'9" (1.75)	6'11" (2.11)	7'6" (2.29)	9' (2.75)
H	3' (0.92)	3'8" (1.11)	3'11" (1.20)	4'9" (1.45)
I	4'11" (1.49)	5'11" (1.80)	6'5" (1.95)	7'8" (2.34)
J	6'9" (2.06)	8'2" (2.48)	8'10" (2.69)	10'7" (3.23)

Charts show the values in the following area angle adjustment settings ; Depth :0° Width :0°

Specifications

Model	AIR-SLIDET
Cover color	Black
Mounting height	6'7" (2.0 m) to 9'10" (3.0 m)
Detection area	See DETECTION AREA
Detection method	Active infrared reflection(*1)
Area angle adjustment	Depth : -8° to +8° Width : ±7° (2 clicks with 3.5° every click-Left/Right)
FLEX EYE angle adjustment	Depth : -14° to +2° Width : ±42° (7 clicks with 6° every click-Left/Right)
Power supply (*2)	12 to 24 V AC ±10% (50 / 60 Hz) 12 to 30 V DC ±10%
Power consumption	< 2.5 W (< 6 VA at AC)
Operation indicator	See Operation indicator table
Test input	Opto coupler Voltage / 5 to 30 V DC Current / 6 mA Max. (30 V DC)
Activation output	Form A relay 50 V 0.3 A Max. (Resistance load)
Safety output	Form A relay 50 V 0.3 A Max. (Resistance load)
Operating temperature	-31 to 131°F (-35 to +55°C)
Operating humidity	< 80%
Noise level	< 70 dBA
Output hold time	Approx. 0.5 sec.
Response time	< 0.3 sec.
IP rate	IP54
Weight	8.1 oz (230 g)
Accessories	1 Operation manual 2 Mounting screws 1 Mounting template 1 Area adjustment tool 1 Cable 9'10" (3 m) (8 × 0.22 mm ² AWG24) (*3)

*1 : BLUEZONE (1st row), 2nd and 3rd rows have a presence detection function.
*2 : When using this sensor, the sensor has to be connected to a door system which has the SELV circuit.
*3 : Overcurrent protection with less than 2A.

Dimensions

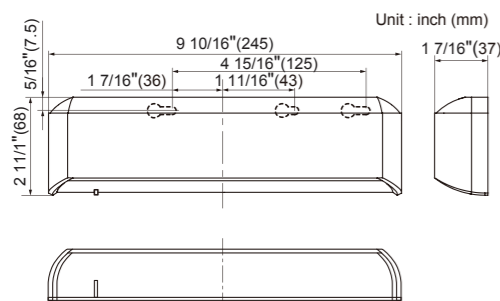

Option



Active Infrared Door Sensor with Built-in Touchless Switch AIR-SLIDET

Wave your hand Here to open door.



Manufacturer / Asia sales Div.

OPTEX CO.,LTD.
5-8-12 Ogoto Otsu Shiga 520-0101 Japan
TEL: +81- (0) 77-579-8700 FAX: +81- (0) 77-579-7030
WEBSITE: www.optex.co.jp/as/eng/index.html

North and South American Subsidiary

OPTEX Technologies Inc.
Corporate Headquarters
18730 S. Wilmington Ave. Suite 100 Rancho Dominguez, CA 90220 U.S.A.
TOLL-FREE: 800 877 6656 FAX: +1 310 214 8655
WEBSITE: www.ot-inc.com
East Coast Office
8510 McAlpines Park Drive, Suite 108 Charlotte, NC 28211 U.S.A.
TOLL-FREE: 800 877 6656 FAX: +1 704 365 0818
WEBSITE: www.ot-inc.com

European Subsidiary

OPTEX Technologies B.V.
Henricuskade 17, 2497 NB The Hague, The Netherlands
TEL: +31(0)70 419 41 00 FAX: +31(0)70 317 73 21 E-MAIL: info@optex.eu
WEBSITE: www.optex.eu

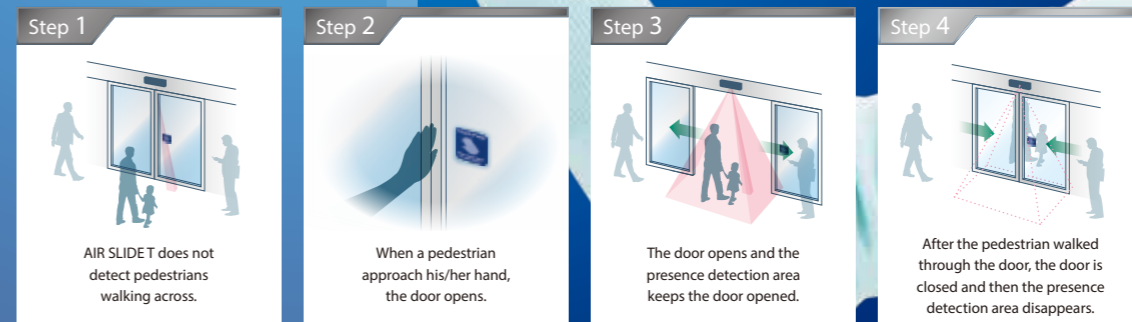

No wiring,
No contamination,
No wasting energy.



Energy Saving

Eliminates unwanted activations due to cross traffic to improve air conditioning efficiency.

Shop owner

I would like to avoid unnecessary door openings due to cross traffic to improve air conditioning efficiency. My shop is facing with a busy street.



Germ Free

Eliminates one of the only cross contamination points on a low energy or knowing act door.

Nurse

Touch switch is contamination points for a knowing act or low energy door. I want to open a door without touching anything.



Safety

Provides safety throughout the threshold area keeping the door open until all people have moved away.

Chef

I want an automatic door for my kitchen but what I need is a limited detection area because my staff is walking around in front of a door.

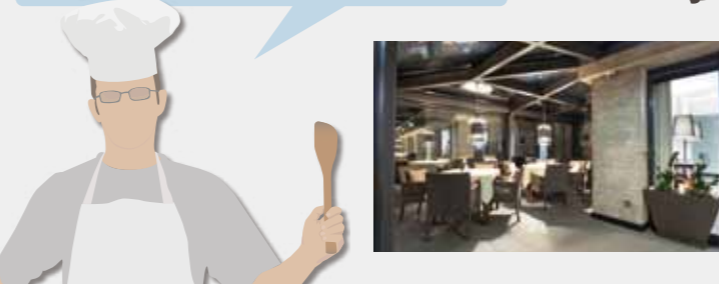

Active Infrared Door Sensor AIR-SLIDE T

FLEX EYE (knowing act detection area)

Blue zone Active infrared

This sensor is designed to detect a hand approaching to a touchless plate as a knowing activation device. FLEX EYE means a detection area for the hand detection. When FLEXEYE mode is enabled, both FLEXEYE and 2nd to 4th row of detection area will detect passers.

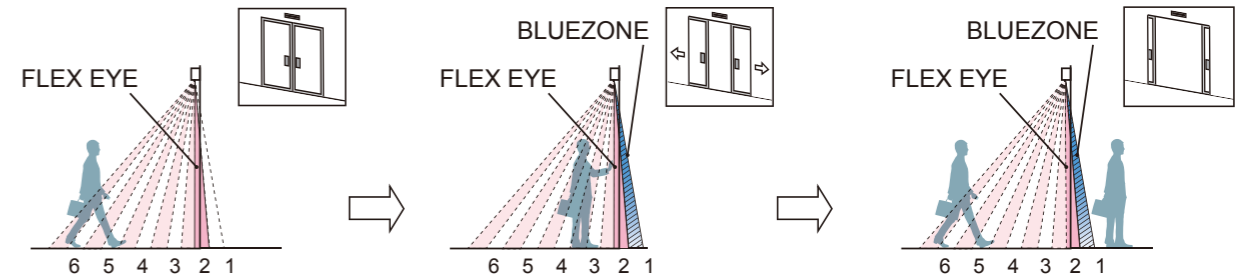

Width angle adjustment

Depth angle adjustment

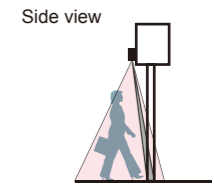
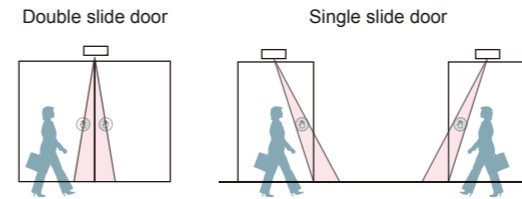
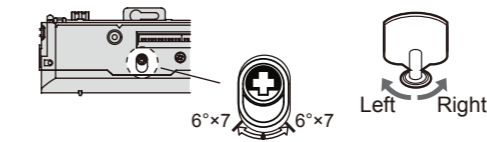

BLUEZONE technology



How it Works: When the approach area detects a person or object, the sensor will activate the door and turn on the "BLUEZONE" which detects through the threshold. As long as someone is in the detection area, the sensor will keep the door in the open position. Once the area is cleared, the "BLUEZONE" will ignore the door panels and allow the door to safely close.

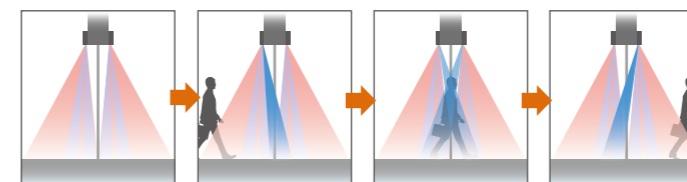

NO WIRING from the sensor to the touchless plate



Monitoring Capability

Complied with New ANSI standard

AIR-SLIDE T has built-in "monitoring capability". The AIR-SLIDE T monitors all its critical functions and notifies compatible controls when an error occurs. Self monitoring capability ensures a higher level of performance over the life of the sensor.

Adapted in Cold District

-31 to 131°F (-35 to +55°C)