

Active Infrared Door Sensor for Industrial Use

OA-6000 series



Activation and Safety infrared sensor for Roll-up door applications.

Unique design enable you to install at lower position when you have pain to climb up to header all the way.

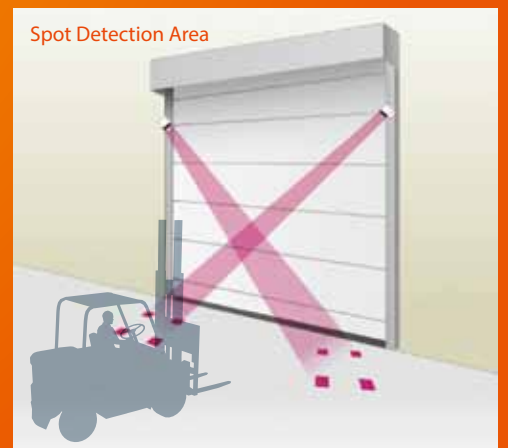

Controller unit OA-6000R

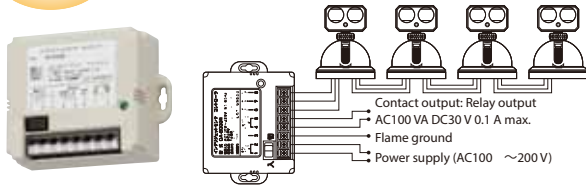

Sensor / Controller All in one unit OA-6000T

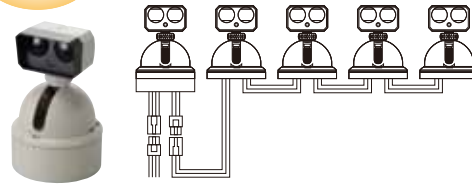

Detection Area

Front view

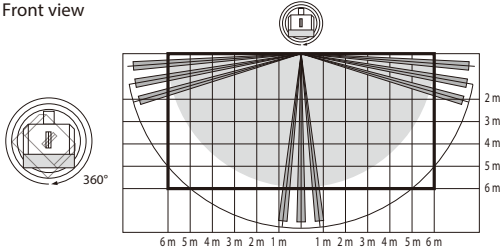

Side view

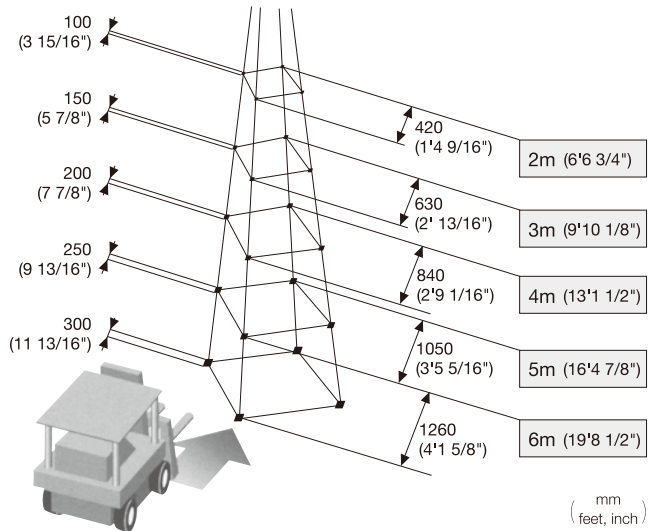
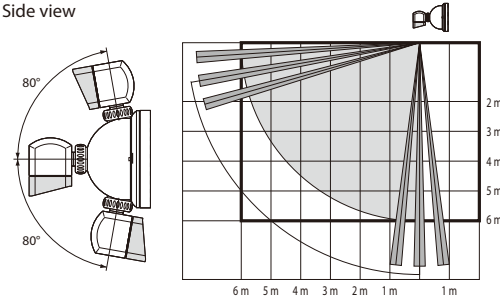

Dimensions

OA-6000S OA-6000T

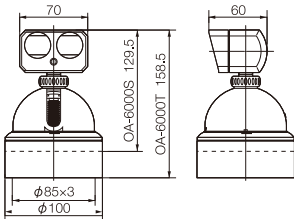

OA-6000R

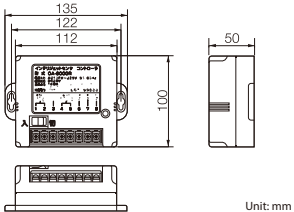

Specifications

Model	OA-6000S	OA-6000T	Model	OA-6000R
Detection range	2 to 6 m		Power supply	100 V to 220 V AC
Detection method	Active infrared reflection method		Power consumption	< 25 VA (100V AC) < 32 VA (200 V AC)
Detection range (vertical)	-80° to +80° (Deep/Shallow)		Operation indicator	LED ON: Stand-by LED OFF: Detection
Detection range (right & left)	360°		Output	"Form A" relay 100 VAC 1 A Max. 30 VDC 0.1 A Max.
Power supply	24 VDC		Relay hold time	Approx. 0.5 sec.
Power consumption	< 65 mA (24 VDC)	< 105 mA (24 VDC)	Operating temperature	-20 to +55°C
Operation indicator	LED ON: Stand-by LED OFF: Detection LED Bl ink: infinite detection		Weight	240 g
Output	NPN 40 mA Max. / 24 VDC	"Form A" relay AC100 V 1 A DC30 V 0.1 A Max.	Accessories	Mounting screw X 1set Operation manual X 1 Mounting template X 1
Relay hold time	Approx. 0.5 sec.			
Operating temperature	-20 to +55°C			
Weight	200 g	290 g		
Accessories	Mounting screw X 1set Operation manual X 1 Mounting template X 1			

Manufacturer / Asia sales Div.

OPTEX CO.,LTD.

5-8-12 Ogoto Otsu Shiga 520-0101 Japan
TEL.: +81-77-579-8360 FAX.: +81-77-579-8190

Asia Sales Div.

TEL.: +81-77-579-8030 FAX.: +81-77-579-8136
WEBSITE: www.optex.co.jp/as/eng/index.html

North and South American Subsidiary

OPTEX INCORPORATED. AMERICAS HEADQUARTERS

18730 South Wilmington Ave. Suite 100 Rancho Dominguez, CA 90220 U.S.A.
TOLL-FREE: 800 877 6656 FAX.: +1 310 214 8655
WEBSITE: www.ot-inc.com

East Coast Office

8510 McAlpines Park Drive, Suite 108 Charlotte, NC 28211 U.S.A.
TOLL-FREE: 800 877 6656 FAX.: +1 704 365 0818
WEBSITE: www.ot-inc.com

European Subsidiary

OPTEX Technologies B.V.

Henricuskade 17, 2497 NB The Hague, The Netherlands
TEL.: +31(0)70 419 41 00 FAX.: +31(0)70 317 73 21 E-MAIL: info@optex.eu
WEBSITE: www.optex.eu